

# OERTLI



Excellence in solid wood

## **CASTOR Optimo**

The fastest milling head

... in many applications

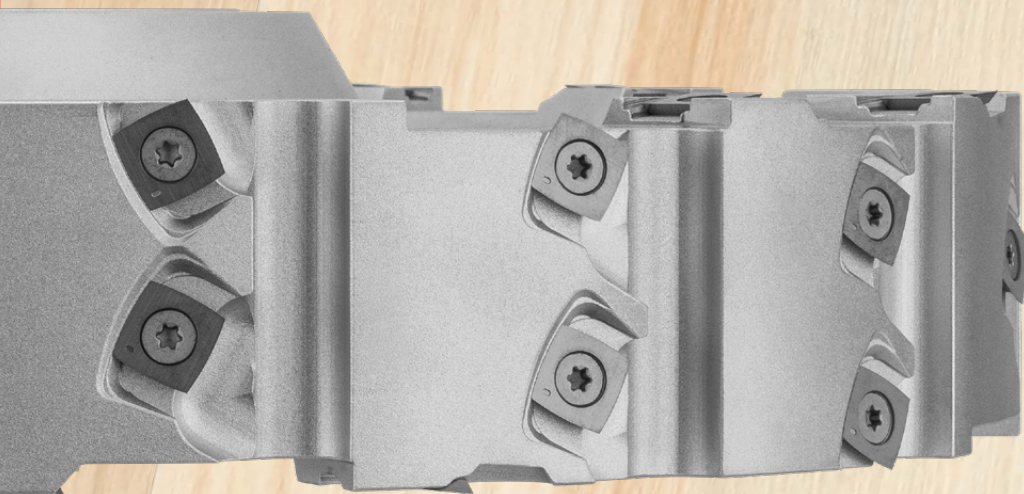

# CASTOR Optimo

## The fastest milling head ... for many applications

There are multiple benefits with the new CASTOR Optimo.

The new milling head saves valuable working time for many applications thanks to its increased feed rate, optimal chip removal and a surface quality with minimal wave patterns in the cutting overlapping area.

You will gain from increased productivity, no matter whether you're planing, rebating or shaping, on the four-cutter for finishing or pre-planing, or even on the joinery machine for cervical milling or shaping curved pieces.

**CASTOR Optimo: In other words, the number one high-performance tool for machining solid wood.**



Milling head with 3 flutes

## What can the CASTOR Optimo offer you?

### Shorter production times

- High volume chip removal
- Processing with minimal cutting pressure
- Minimal reworking
- Deep cutting and high feed rate with maximum cutting edge division
- Avoidance of tears in naturally-grown forest woods

### Higher quality surface finish

- Clean, finest surface with tangible undulations

### Lower investment costs, simpler tool maintenance

- Groove, rebate, plane, chamfer, cervical and face milling in a single tool
- All knives with four cutting edges - four times the service lifespan
- The same cutting edges, also as spure knife

### Low noise manufacturing conditions

- Significant reduction in noise level

### Low energy consumption

- 15% less energy consumption with the same feed rate and rotation speed, or higher productivity with the same machining parameters



Milling head with 4 flutes

## What is new about the CASTOR Optimo?

- The greater distribution of the cutting edges to three or four flutes reduces the cutting pressure and enables a greater overall performance.
- The specific arrangement of the cutting edges in spiral flutes prevents chips from getting jammed and ensures interruption-free processing.
- The spacious distribution of cutting edges reduces cutting power per cut and thus optimises the entire system's performance.
- Consistently high axis angle for minimal post-processing, avoidance of lacerations, improved surface quality and other benefits.
- Simplified cutting management with the same types of cutting throughout the entire system.
- Six traditional processing methods using the CASTOR Optimo system: Groove, rebate, plane, chamfer, cervical and face milling.

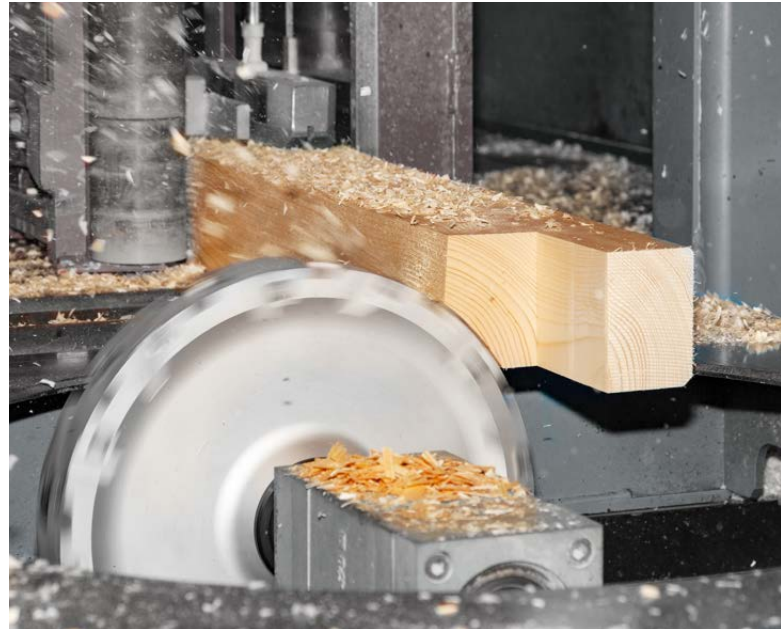

S3 rebating, with spure knives on one side

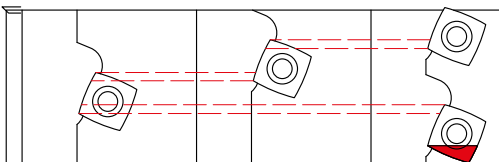

S4 rebating, with spure knives on one side

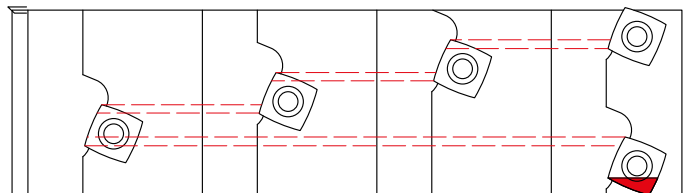

S3 jointing, no spure knives

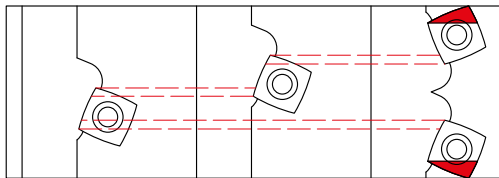

S4 jointing, no spure knives

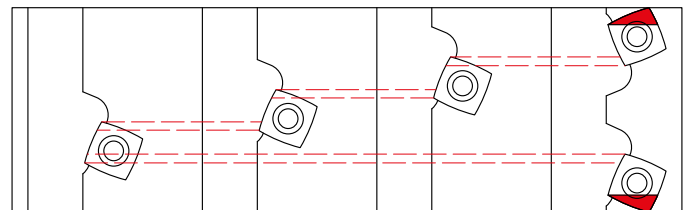

S3 grooving, with spure knives on both sides

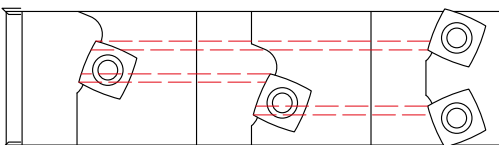

S4 grooving, with spure knives on both sides

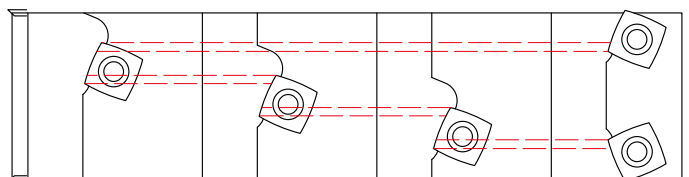

**OERTLI Werkzeuge AG**

CH-8181 Höri  
T +41 44 863 75 11  
info@oertli.ch

**OERTLI gereedschappenfabriek bv**

NL-4902 TT Oosterhout  
T +31 162 51 48 80  
oertli@oertli.nl

**OERTLI Werkzeuge GmbH**

A-6800 Feldkirch  
T +43 5522 75 78 70  
info@oertli.at

**OERTLI Werkzeug- und  
Maschinenhandels-GmbH**

D-73486 Adelmansfelden  
T +49 7963 84 19 00  
info@oertli-werkzeuge.de

**OERTLI Magyarország KFT**

H-8900 Zalaegerszeg  
T +36 92 33 40 81  
info@oertlikft.hu

**OERTLI Tooling UK Ltd**

LE19 4SA Leicester  
T +44 116 286 34 09  
info@oertli.co.uk

**OERTLI France**

F-21000 Dijon  
T +33 3 80 55 16 62  
info@oertli-outils.fr

**[www.oertli.com](http://www.oertli.com)**