

Operating Instruction Manual

Eccentric Knife Clamping System

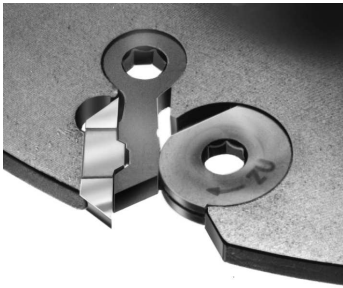

These operating instructions are part of your product and are intended for all persons who perform work with this tool. They must be read and understood before the initial operation of the tool and must always be stored in an accessible manner.

Always use original spare parts from OERTLI Werkzeuge AG.



Translation of the original instructions

Index

1. Description	3
1.1. Appropriate Application	3
1.2. General warranty conditions	3
2. Security Advice	3
2.1. Signal words	3
2.2. General sources of risk	4
2.2.1. <i>Injuries due to contact with cutting parts</i>	4
2.2.2. <i>Falling parts</i>	4
2.2.3. <i>Defective parts or elements</i>	4
2.2.4. <i>Fastening torque</i>	4
2.2.5. <i>Modification of OERTLI products</i>	4
2.3. Protective equipment required	5
3. Start Up	5
3.1. Unpacking/Transportation	5
3.2. Installation/Assembly	6
4. Attendance/Operation	6
4.1. Prior to operation	6
4.2. Possible Feed Systems	7
4.3. Allowable range of spindle RPM	7
4.3.1. <i>Marking of tools and tool sets</i>	8
4.4. Application parameters	8
4.5. Reasons for a possible knife -, resp. tool rupture	8
5. Maintenance/Cleaning	9
5.1. Maintenance Work	9
5.1.1. <i>Instructions for changing knives</i>	9
5.1.2. <i>Tightening torques</i>	11
5.1.3. <i>Behaviour after a tool collision</i>	11
5.1.4. <i>Cleaning</i>	11
6. Preservation/Storage/Disposal	12
6.1. Preservation/Storage	12
6.2. Disposal	12
7. Contacts/Addresses	12
8. Glossary	14
8.1. Technical terms	14
8.2. Item numbering structure	16
8.2.1. <i>A - prefix</i>	16
8.2.2. <i>B - number part</i>	16
8.2.3. <i>C - suffix</i>	16
8.3. Drawing numbers	17
8.4. Symbols	17
8.5. Unit	17
8.5.1. <i>Table of units</i>	17

1. Description

The Eccentric Knife Clamping System is one of the possible clamping systems used in tool sets comprising of one or several single cutters. Tools with this system are designed with a smooth kickback-free performance. The tungsten carbide eccentric knives are clamped firmly and securely. Other tool systems are described in separate operating manuals.

1.1. Appropriate Application

Tools with the Eccentric Knife System should be used exclusively for wood-cutting applications such as profiling and grooving under consideration of suitable operating conditions.

Materials to be cut are:

- Softwoods
- Hardwoods
- Exotic woods
- Particle boards
- MDF (medium density fibreboard)
- Laminated pressed woods
- Composite materials (wood and plastic)

Place and mode of application:

- Woodworking machinery
- primarily for groove and profile applications
- Feed systems: Manual feed or Mechanical feed, according to tool inscription
- Speed range (RPM), respectively max. speed according to tool inscription

1.2. General warranty conditions

The warranty services only include the repair or replacement of defective tools and clamping devices made by OERTLI that are subject to manufacturing or material faults. The warranty period starts with the date of purchase and is specified in the general conditions of business.

2. Security Advice

Our clamping devices and tools correspond to the state of the art and were produced in

accordance with EN 847-1 and the subsequent European Standards.

The regulations of the machine manufacturer must be adhered to for safe use of the clamping device or tool. The relevant regulations are provided in the respective operating instructions of the wood processing machine used.

Obtain information regarding the location and function of the safety devices required for your wood processing machine before using the tool.

Work may only be performed by appropriately trained specialist staff familiar with handling wood processing tools and machines as well as the relevant clamping devices.

This tool or clamping device may only be used for the purpose described under "appropriate use" and in compliance with the following safety instructions.

2.1. Signal words

The following Signal words refer to the different levels of danger:

DANGER

The "DANGER" signal word indicates a hazardous situation which, if not avoided, will result in death or serious injury.

WARNING

The "WARNING" signal word indicates a hazardous situation which, if not avoided, could result in death or serious injury.

CAUTION

The "CAUTION" signal word indicates a hazardous situation which, if not avoided, could result in minor or moderate injury.

NOTICE

The "NOTICE" signal word indi-

cates risks that might result in damage to goods.

2.2. General sources of risk

2.2.1. Injuries due to contact with cutting parts

Source of risk	Contact with cutting parts on the tool.
Consequences	Cutting, piercing and crushing injuries.
Probability	Contact with the tool always poses a risk of injury.
Avoidance	Wear safety gloves that were tested according to EN 388.
In emergencies	Perform first aid. Consult a doctor.

2.2.2. Falling parts

Source of risk	Damage to persons or goods due to falling parts.
Consequences	Crushing, bruises in the foot area and/or damaged tool.
Probability	Always during transport or inappropriate storage.
Avoidance	Transport in suitable packaging or device. Wear suitable safety shoes.
In emergencies	Perform first aid. Contact the supplier/manufacturer.

2.2.3. Defective parts or elements

Source of risk	Worn or wrongly mounted parts that may cause eccentricity or reduce the clamping force.
Consequences	Damage to the tool.

Probability During installation and removal work and after prolonged use or storage.

Avoidance By regular, visual inspection. Only use original parts.

In emergencies Check the tool for damage. Have the tool promptly checked by the manufacturer when damage has occurred.

2.2.4. Fastening torque

Source of risk Tightening screws that have been fastened with too low or too high fastening torque.

Consequences Damage to the tool due to reduced clamping force of the clamping system.

Probability When the tool has not been used for a prolonged time.

Avoidance Fasten all screws using a low-recoil torque wrench. Check tightening screws that have not been loosened for a prolonged period (e.g. after preservation).

In emergencies Immediately deactivate the tool and have it inspected by the manufacturer as required when the tightening screws can no longer be fastened with the fastening torque specified.

2.2.5. Modification of OERTLI products

Source of risk Unauthorised modifications of tools and clamping devices by the user.

Consequences Severe damage to persons and/or goods.

Probability	Always in case of unauthorised modifications by the user.
Avoidance	Only have modifications performed directly by the OERTLI company or with their approval. Always use original spare parts.
In emergencies	Perform first aid. Contact the supplier/ manufacturer.

2.3. Protective equipment required



Protective goggles
Protective goggles protect the eyes against flying particles during wood processing and against possible splashes of liquid during tool cleaning.



Safety gloves
Safety gloves protect against cutting and piercing injuries while touching, mounting or removing the tool. Only use safety gloves that have been tested according to EN 388 (mechanical risks).



Hearing protection
Hearing protection protects the ears from increased noise exposure during wood processing.



Safety shoes
Safety shoes are used to protect the feet against dropping objects.

Any additional protective equipment that may be required is specified in the operating instructions of the machine manufacturer..

3. Start Up

3.1. Unpacking/Transportation

⚠ WARNING



Very sharp cutting edges pose a risk of cutting and piercing when touching the tool.

Be cautious when unpacking or packing as well as when handling.

Do not touch tools at the cutting edges.

Wear appropriate protective gloves (according to EN 388).

⚠ WARNING



Risk of cutting and crushing by dropping tools.

Only transport and store tools in suitable packaging or devices.

Ensure that the tool is correctly positioned in the holder.

Wear appropriate safety shoes when working with heavy tools.

NOTICE

Damage to the clamping adaptor and to the tool due to strike against foreign material.

Be cautious when unpacking or packing as well as when handling.

Always put tools on soft supports.

Transport clamping adaptors and tools only in a suitable packing.

Always use the original packing for transport.

3.2. Installation/Assembly

NOTICE

Clamping adaptors with steep cone shank require a holding bolt. Without it, the tool is not held in the spindle.
Damage to the clamping adaptor and the tool due to not mounting a holding bolt.

Mount the corresponding holding bolt into the steep cone shank before the tool is put onto the machine.

NOTICE

Damage to the tool, to the cutting edges and to the knife clamping systems as well as to the clamping adaptors due to loss of clamping forces.

All clamping surfaces must be free from dirt, oil, grease and water.

Regularly check all clamping devices for damage and immediately replace damaged devices.

Do not use fibre materials, such as cotton waste for cleaning.

DANGER



Risk of cutting, crushing and mortal danger due to unintentional machine start during tool or cutter exchange.

Disconnect the power supply to the machine.

Ensure that the machine cannot be switched on by third parties during operation.

Mount and secure the clamping adaptors and the tools according to instructions of the machine manufacturer! Consider necessary information from the instruction manual of the woodworking machine in use.

4. Attendance/Operation

WARNING



Danger of injuries or danger of crushing by the rotating tool.

Do not touch the rotating tool.

Do not slow down the tool by lateral pressure against the tool body.

Do not work without necessary safety guard.

4.1. Prior to operation

Check the clamping adaptors and the tools for damage and check the seats of the clamping elements as well as the condition of the cutting edges.

For maintenance work on damaged or dull cutting edges refer to chapter "Maintenance/Cleaning" of the corresponding wood working tool.

For proceeding with respect to preservation and storage, refer to chapter "Preservation/Storage" in this maintenance manual.

WARNING



Tool breakage or cutting edge breakage by overload.

Cutting injuries, crushing injuries or danger of life due to fly-away parts.

Do not re-install neither damaged or modified clamping adaptors and tools nor clamping adaptors and tools with corroded screw connections.

Maintenance work on damaged clamping adaptors and tools to be carried-out only by the manufacturer of clamping adaptors and tools.

Applicable machine parameters such as speed, direction of rotation and feed to be checked and verified with the parameters of the

clamping adaptor and tool.

For compound tools (tipped tools), the rest height or rest thickness of the attached cutting plate is not to be less than 1 mm.

Check screw connections for corrosion after transport or after a longer storage time, respectively a longer unused time. Corroded screws must be replaced. Threaded holes must be checked for correct tolerances and strength.

⚠ WARNING

Due to transport, strong working vibrations or long storage times, alternatively parts not being used for a long time, so called resting-effects may occur due to vibrations and temperature differences on screw connections. As a result, screw clamping forces are considerably lost.

Danger of cutting injuries, crushing injuries or danger of life due to fly-away parts.

Tighten all screws to the required torque before each use.

Protect clamping adaptors and tools with screw connections from vibrations.

Store clamping adaptors and tools at mostly constant temperatures.

4.2. Possible Feed Systems

Single-part tools may be assembled to a tool set or to a tool combination. Tools from such sets or combinations which are not suitable for hand feed will be equipped with a pin in the hub area to avoid using them as single-part tool.



⚠ WARNING

For manual feed exists danger of injuries, danger of crushing or danger of life by tool kick-back.

Manual feed requires working only against the feed.

Do not use individual -with pins secured- tools for manual feed.

The tool inscription indicates whether your tool is suitable for manual feed or for mechanical feed:

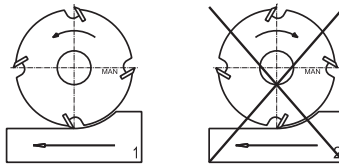

Marking MAN:

=> suitable for manual feed

Operation:

=> only against the feed (1)

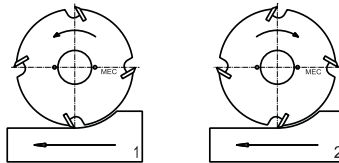

Marking MEC:

=> suitable for mechanical feed

Operation:

=> against the feed (1) or with the feed (2)

Ensure that the correct machine parameters have been set before starting work.

4.3. Allowable range of spindle RPM

⚠ WARNING

Tool breakage due to overload. Cutting injuries, crushing injuries or danger of life by fly-away parts.

Some clamping adaptors are allowed to be used only for one direction of rotation. Check a possibly pretended direction of rotation of the clamping adaptor with that of the tool as well as with that of the machine.

For shank type tools and tools with bore, for example on clamping bushes:

Check the maximum permissible speed of the clamping adaptor with that of the used tools. The respective smallest value is the maximum admissible speed of the corresponding tool combination. Do not exceed the smallest maximum speed of all participating clamping adaptors and tools.

For tools with bore, for example on CNC-clamping shafts:

Tools with bore on CNC-clamping shafts with for example HSK- or Steep Taper Cones are not allowed to be operated without checking the strength.

The operating speed must be checked separately for each tool combination. Whether the calculation for the corresponding tool combination has been made, can be seen on the customer drawing. If no customer drawing is available for a tool combination, the operational stability has to be checked.

⚠ WARNING



For manual feed exists danger of injuries, danger of crushing or danger of life by kick-back of the workpiece, if the allowed range of speed falls short of.

Do not fall short of the allowed range of speed for manual feed.

4.3.1. Marking of tools and tool sets

OERTLI ← A
 XX XXXXXXXX XXX ← B
 D x B x d ← C
 MEC
 n max. 10100 ← D

- A: Brand name / manufacturer
- B: Item / tool number
- C: Dimension [mm] and MAN/MEC marking
- D: Maximum rotation speed or permitted rotation speed [1/min] e.g. n max. 10100

Markings of tools are on the tool body and markings of tool sets are on the clamping device.

4.4. Application parameters

⚠ WARNING

Tool breakage due to overload. Cutting injuries, crushing injuries and danger of life by fly-away parts.

Make sure that operating vibrations are as small as possible.

As required, adjust feed rate, speed and cutting depth.

Improve clamping stability of the work-piece.

4.5. Reasons for a possible knife -, resp. tool rupture

The following reasons may lead to a knife rupture:

- Grinding cracks or change of the cutting geometry due to improper sharpening
- Jerking movements of the work-piece
- Jam of the tool by a waste piece (especially by cut-out work)
- Overheating by friction due to too small feed rate or too small cutting depth as well as due to dull cutting edges
- Too high feed rate
- Too large cutting depth

- Insufficient clamping of the tool
- Vibrations of the machine

NOTICE

High advance during processing may cause damage to the tool.

Check all processing data and adapt or reduce the values as required before each use of the tool.

5. Maintenance/Cleaning

Clamping adaptor quality and tool quality as well as work safety are only guaranteed, if the clamping adaptor and the tool is checked and cleaned before used.

Required tightening torques to be exactly maintained when screws are tightened (use proper torque wrench). Only by this manner sufficient clamping is guaranteed.

⚠ WARNING

Tool- or knife rupture due to imbalance of not mounted reversible- or inserted knives.

Cutting injuries, crushing injuries or danger of life by fly-away parts.

Do not mount unsymmetrically reversible knives and inserted knives.

Always use the same screws and clamping parts per cutting system.

⚠ WARNING

Tool- or knife rupture due to corroded screw connections. Cutting injuries, crushing injuries or danger of life by fly-away parts.

Damaged or corroded screws and clamping parts must be replaced. In addition corresponding threaded holes must be checked for accuracy and strength.

⚠ WARNING

Tool- or knife rupture due to overload from worn -or damaged knife cutting edges.

Cutting and crushing injuries as well as mortal danger during operation due to flying parts.

Use only original spare parts from OERTLI Werkzeuge AG.

For reversible knives or inserted knives:

- Do not re-sharpen, but replace in time
- Do consider thereby the instruction manual for changing knives for the corresponding knife system

For compound tools and single-part tools such as saw blades, diamond tipped cutters or tungsten carbide tipped cutters, solid tungsten carbide spiral cutters:

- Re-sharpen or replace
- Do consider thereby the corresponding information in chapter "Maintenance work"

Dull or damaged cutting edges must be sharpened or replaced, if:

- the wear-out part of the cutting edges are greater than 0.2 mm (consider especially the main wear-out parts!)
- Break-outs on the cutting edge are visible
- Burns on the wood are visible
- the surface on the work piece does not comply anymore with the desired requirements
- the power requirement of the machine increases considerably (more than 10%)

5.1. Maintenance Work

5.1.1. Instructions for changing knives

(See Fig. 1)

The tongue (3) and the eccentric (1) may,

under no circumstances, be detached from the tool!

1. Clean the tool first.
2. Turn the eccentric (1) away from the marked "ZU" arrow direction using an Allen key (see Fig. 1).
3. Turn the tongue with the Allen key away from the knife (2).
4. Remove the knife from the knife seat.
5. Clean the knife seat and all of the components that go with it. Be sure all surfaces are free from dirt, oil, grease and water.
6. Carefully insert the new or reversed knife. Make sure the notch on the front of the knife engages completely in the tongue's groove (see Detail X), in order to ensure the correct radial position. The lateral position results from the V-groove of the knife's back and the cam on the tool body (see Detail Y).
7. Tighten the eccentric with the corresponding torque wrench at the specified torque of 4 Nm. Turn the eccentric in the marked "ZU" arrow direction (see Fig. 1).

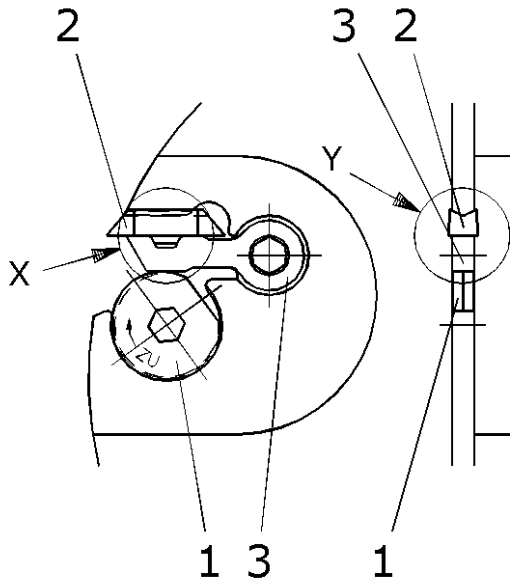
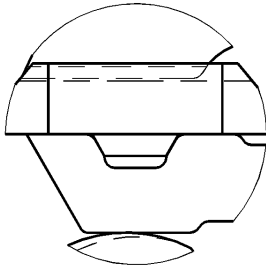
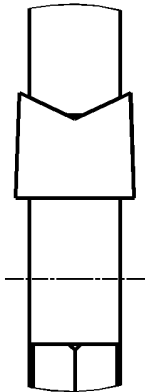

Fig.1



Detail X



Detail Y

5.1.2. Tightening torques

⚠ WARNING

Insufficient clamping, screw breakage or damage due to overload. Risk of injuries and mortal danger during operation due to flying parts.

Use a recoil-free torque spanner.

Do not mount tools or clamping devices in a heated or undercooled state.

The fastening screws must be tightened in a sequence from the middle towards the outside apply-

ing the appropriate torque, when more than two screws per clamping unit have to be fastened.

Eccentric cam $\varnothing 14$ mm with Hexagon Socket Head 4 mm = 4 Nm

5.1.3. Behaviour after a tool collision

⚠ DANGER



After a tool collision or after high working vibrations, the strength of the brittle cutting edge material and the hardened clamping adaptor is not guaranteed anymore. High vibrations or a collision of the tool act like blows on the cutting edges. For very high loads due to high cutting speeds in woodworking, such pre-damaged tools and clamping adaptors may lead to tool rupture. Ruptured tool parts act like bullets at high working speeds! Danger of cutting injuries, danger of crushing or danger of life due to fly-away ruptured tool parts!

Do not re-use damaged tools or deformed tools and clamping adaptors.

Repair work and maintenance work on tools and clamping adaptors to be carried-out only by the tool manufacturer.

Tool and clamping adaptor to be checked for micro-damages. In addition, verify the tool connection of the machine.

5.1.4. Cleaning

NOTICE

To achieve highest precision and best performance, it is important to clean tools and clamping adaptors regularly as required according to application.

Damage of the tool, the cutting edge and the knife clamping system as well as the clamping adap-

tor due to loss of the clamping force.

All surfaces used for clamping must be free from dirt, oil, grease and water.

Rinse and dry tools after cleaning with a solvent.

Do not use fibrous materials, such as cotton waste, for cleaning.

6. Preservation/Storage/Disposal

6.1. Preservation/Storage

If the tool or clamping adaptor is not being used for a longer period of time (> 6 months), it should be prepared for storage as follow:

- With the exception of fix screwed Hydro-clamping components, tool sets or tool combinations must be first dismantled into single tools.
- Clean well the single tools and clamping adaptors such as for example bushes, shafts, collets and chucks. For details, please refer to chapter "Cleaning" of the corresponding maintenance manual.
- For tools with inserted knives or reversible knives, all knife clamping systems must be dismantled and cleaned. Please refer to chapter "Cleaning" of the corresponding maintenance manual.
- Make sure that all clamping- and contact surfaces are free from dirt, oil, grease and water.
- For tools with inserted knives or reversible knives, the knives can now be re-mounted. Please refer therefore to chapter "Maintenance work" in the corresponding operating manual.
- Treat the dried single tools and clamping adaptors with a customary available preservation oil.
- Single tools and clamping adaptors may now be re-assembled.
- Store the conserved tools and clamping adaptors in a room, which is not exposed to large temperature fluctuations (20°C +/- 10°C).

NOTICE



Danger of corrosion by storing unconserved tools and clamping adaptors.

Always conserve tools and clamping adaptors, if not in use.

Do not put into operation tools and clamping adaptors with corroded screw connentions. Corroded screws must be replaced.

Threaded holes must be checked for accuracy as well as for strength.

6.2. Disposal

Dispose of tools and clamping devices in accordance with the local and national environmental regulations in your country.

Please take note of the disposal instructions of the cleaning agent manufacturer when disposing of the cleaning agent.

7. Contacts/Addresses

Switzerland
OERTLI Werkzeuge AG
Hofstrasse 1
CH-8181 Höri bei Bülach
Phone: +41 44 863 75 11
Fax: +41 44 863 75 12
E-Mail: info@oertli.ch
Website: www.oertli.ch

Benelux
OERTLI Gereedschappenfabriek B.V.
Elftweg 4
NL-4940 AB Raamsdonksveer
Phone: +31 162 51 48 80
Fax: +31 162 51 77 87
E-Mail: oertli@oertli.nl
Website: www.oertli.nl

Austria
OERTLI Werkzeuge GmbH
Industriepark Runa
AT-6800 Feldkirch
Phone: +43 5522 75787 0
Fax: +43 5522 75787 3
E-Mail: info@oertli.at
Website: www.oertli.at

Germany

OERTLI Werkzeug- und Maschinenhandels-
GmbH

Schillerstrasse 119

DE-73486 Adelmansfelden

Phone: +49 7963 841 900

Fax: +49 7963 841 909

E-Mail: info@oertli-werkzeuge.de

Website: www.oertli-werkzeuge.de

Estonia

Kaur Trade OÜ

Rehepapi tee 23

EE-61709 Soinaste küla

Phone: +372 7 307 250

Fax: +372 7 367 241

E-Mail: info@kaurtrade.ee

Website: www.kaurtrade.ee

China

AKE Precision Tooling (TaiCang) Co., Ltd.

1st Floor, Building 2,

Hongliang Industry Park

1st Outer Ring Road

CN-215400 TaiCang, JiangSu Province

Phone: +86 512 53 18 51 51

Fax: +86 512 53 18 50 50

E-Mail: info@aketools.com

Italy

OERTLI Italia S.r.l.

Via Caporalino 21/a

IT-25060-Cellatica-Brescia

Phone: +39 30 277 2801

Fax: +39 30 277 1192

E-Mail: oertli@hotmail.it

Website: www.oertli.it

Sweden

Kvarnstrands Verktyg AB

Storgatan 11

SE-57450 Ekenässjön

Phone: +46 38 33 47 00

Fax: +46 383 383 30027

E-Mail: info@kvarnstrands.com

Website: www.kvarnstrands.com

Hungary

OERTLI Magyarország Kft.

Marton Lajos u.2.

HU-8790 Zalaszentgrót

Phone: +36 83 560 005

Fax: +36 83 560 006

E-Mail: oertlikft@t-online.hu

Website: www.oertli.hu

Russia

AKE RUS

Polustrovsky pr. 28 G

28-Zh, office 18

RU-195197 St. Petersburg

Phone: +7 812 347 84 90

Fax: +7 812 347 84 94

E-Mail: info@ake.de

United Kingdom and Ireland

OERTLI Tooling UK Ltd.

7 Warren Park Way Enderby

Leicester

UK-LE19 4SA

Phone: +44 116 286 34 09

Fax: +44 116 286 75 45

E-Mail: info@oertli.co.uk

Website: www.oertli.co.uk

France

OERTLI France

Résidence Jean Le Bon

13 avenue Albert Camus

FR-21000 Dijon

Phone: +33 3 8055 1662

Fax: +33 3 8055 1691

E-Mail: info@oertli-outils.fr

Website: www.oertli-outils.fr

Poland

AKE Polska Sp. z o.o.

ul. Witosa 7

PL-98-400 Wieruszów

Phone: +48 62 7832 200

Fax: +48 62 7832 201

E-Mail: ake@ake.pl

Website: www.ake.pl

Romania

SORIN MIHAI s.r.l.

Str. De Mijloc 183

RO-500064 Brasov

Phone: +40 268 472 159

Fax: +40 268 472 193

E-Mail: office@sorinmihai.ro

Slovenia

KTP d.o.o.
Kolodvorska cesta 28a
SI-6230 Postojna
Phone: +386 590 72140
Fax: +386 590 72149
E-Mail: info@ktp.si

Latvia and Lithuania

B.R.A.N.G.S. Ltd.
Brivibas 22
LV-5001 Ogre
Phone: +371 293 734 13
Fax: +371 650 227 31
E-Mail: a.spulis@oertli.com

Australia

Fenestration Solutions Australia Pty Ltd
1/11 Ashley Park Dve
Chelsea Heights
VIC Australia, 3196
Phone: +61 3 9773 3966
Fax: +61 3 9773 3988
E-Mail: sales@fsa.us.com.au
Website: www.fsa-us.com.au

Czech Republic

OERTLI Partner Czech Republic
Sluneční 2417
CZ-75661 Rožnov pod Radhoštěm
Phone: +420 608 750 788
E-Mail: hastry22@gmail.com

USA

KYOCERA UNIMERCO Tooling Inc.
6620 State Road
Saline, MI 48176
Phone: +1 734 944 4433
Fax: +1 734 429 5177
E-Mail: ummi@kyocera-unimerco.com
Website: www.kyocera-unimerco.us

Spain

Preziss Diamant
Poligono Industrial, Les Pedreres Nave A-1
ES-08390 Montgat
Phone: 0034/93 469 03 51
Fax: 0034/93 469 22 79
E-Mail: preziss@preziss.com
Website: www.preziss.com

8. Glossary

8.1. Technical terms

Deflector

Protruding safety component that limits the clamping thickness.

Bore cutter (also bore tool)

A tool with a bore in the centre that is used to fasten the tool to the clamping device.

Pressure jaw

A clamping element that creates contact pressure to fasten a cutter to a tool.

Clamping eccentricity

Radial inaccuracy that results when a tool is clamped.

One-piece tools

Solid tools that are completely made of the same material.

Cutting circle diameter

Diameter range of the cutting edge and therefore largest outer diameter of the cutter.

Up-cut milling

During up-cut milling, the cutting movement of the tool proceeds against the relative advance movement of the work piece. The tool edge always enters the work piece by scraping and pressing.

Climb milling

Only suitable for mechanical advance. During climb milling, the cutting movement of the tool proceeds in the same direction as the relative advance movement of the work piece. The tool edge enters the work piece by cutting.

Helicoil

A Helicoil (brand name) is a wire thread insert for internal threads.

Cutter seat

Area in the support body that holds the cutters, which are fastened inside it by clamping elements.

Mean chip thickness

The mean chip thickness is the average thickness of a chip.

Resharpener

Sharpening the cutting edges of pre-used, blunt cutters.

Residual imbalance

Permitted imbalance range of the tool after balancing.

Recoil (also tool recoil)

Uncontrolled flinging away of the work piece or of work piece parts against the advance direction.

Shaft cutter

Single-part or compound tools that have cutters immediately next to the shaft (clamping area).

Grinding cracks

Grinding cracks are small micro-cracks that may occur during sharpening of cutters.

Cutter overhang

This is the radial distance between cutting edge and the circumference of the cutter body.

Cutter exchange

Replacement of blunted cutters with new cutters without complete removal of the tool.

Cutting speed

This is the speed at which the tool cutting edge moves in the cutting direction through the material to be processed. The cutting speed is specified in metres per second.

SP-Technik or HPC/HPC+

Tools with SP-Technik or HPC/HPC+ are connected free of clearance on the clamping device. They form a functional unit which can be operated at much higher process parameters.

Chip breaker

This is a clamping element that is used between the pressure jaw and the cutter. A chip breaker ensures optimal chip breakage during the milling process.

Chip gap width

Tangential distance from the cutter edge to the deflector or circumference of the support body.

Clamping screw

The clamping screw (fastening element) produces the retaining force required by the pressure jaw to retain the cutter.

Service life

The service life is the duration that a tool can work without interruption until considerable signs of wear occur and the tool has to be replaced.

Support body

Basic body that carries the cutters.

Compound tools

Tipped tools that consist of a support body and firmly attached (not removable) cutters.

Precutter

Cutter part that can cut at the circumference as well as the front edge. It extends past the main cutter in a radial and possibly also in an axial direction.

Advance speed

Speed in meters per minute at which the tool processes the wood.

Exchangeable cutters

These are removable cutters that can be exchanged for new ones once they have reached the end of their service life.

Reversible cutters

These are cutters that can be reversed and can therefore be used several times.

Tool quality

Quality level of the tool.

Tool set

This is a combination of several individual tools that are jointly clamped onto one shaft or one bushing.

Tooth feed

Distance between two subsequent cutting surfaces in the advance direction.

Composite tool

Tool consisting of a support body, cutting edges and fastening elements that together form a unit.

8.2. Item numbering structure

An OERTLI item number has the following structure:

XX **XXXXXX** **XX**
A B C

8.2.1. A - prefix

The prefix always has two characters and includes the following abbreviations:

TA = Standard parts
TB = Standard parts
TE = Tool set (special tools)
TO = Individual tool (special tools)
TV = Various special parts

KC = Profile knife
KP = Profile knife
KX = Profile knife
KW = WIN knife
KG = Straight knife
KN = Groove knife
KF = Format knife
KR = Serrated knife

Example:

TA469720 = Standard part

8.2.2. B - number part

This is a 6 or 10 digit number between the prefix and the suffix and accurately identifies the item.

8.2.3. C - suffix

This suffix may contain the following information:

Cutter quality:

H8 = Standard hard-metal quality
H6 = Hard hard-metal quality
C01 = Coating Type 1
C02 = Coating Type 2
HS = High-alloy high-speed steel
HW = Hard metal
DP = Diamond

Only the H8 hard metal quality is an exception, as it is used as standard by the OERTLI company. Item numbers for hard metal quality H8 do not have a suffix.

Examples:

KP171300 = H8 (hard metal quality)

KP171300H6C02 = H6 with coating

Profiled clamping parts:

Individual clamping parts carry their own marking when they are used in clamping systems for profiled clamping parts. This allows for easier identification of the individual clamping parts.

Description types:

APL = Deflector

PI/PA = Protect

SPL = Support plate

DRB = Profiled pressure jaw

Example:

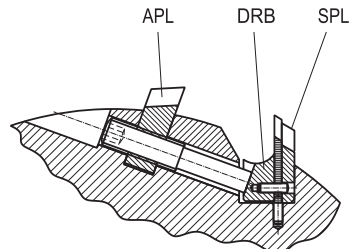

KP171300 = Cutter

KP171300SPL = Support plate

KP171300DRB = Profiled pressure jaw

KP171300APL = Deflector

Shortened standard cutters:

Standard cutters that were individually shortened have the following suffix:

L + shortened length in millimetres

Example:

TA469720L195 (shortened to 195 mm)

8.3. Drawing numbers

The drawing numbers of the OERTLI company are structured like the following example:

TE 1511199 001 01 A
A B C DE

- A: Drawing type (prefix)
- B: Project number
- C: Running number
- D: Version number
- E: Change index (alphabetically increasing)

8.4. Symbols



Use of damaged tools prohibited



Warning of rotating tool



Warning of cutting injuries



Warning of recoil



Warning of caustic substances



Read the operating instructions



Wear safety gloves



Wear protective goggles



Wear hearing protection



Wear safety shoes

8.5. Unit

8.5.1. Table of units

Parameter	Unity	Translation
Length	[mm]	x 0.03937 = [inch]
Length	[m]	x 39.370 = [inch]
Weight	[g]	x 0.035 = [oz]
Weight	[kg]	x 2.2046 = [lb]
Force	[N]	x 0.22481 = [lbf]
Force	[kN]	x 101.9716 = [kp]
Torque	[Nm]	x 0.738 = [lbf ft]
Pressure	[bar]	x 14.504 = [PSI]
Temperature	[°C]	(°C x 1.8) + 32 = [°F]
Rotation speed	[1/min]	---
Density	[kg/m³]	---